

ZXLD1352

350mA LED driver with internal switch and enhanced PWM dimming range

Description

The ZXLD1352 is a continuous mode inductive step-down converter, designed for driving single or multiple series connected LEDs efficiently from a voltage source higher than the LED voltage. The device operates from an input supply between 7V and 30V and provides an externally adjustable output current of up to 350mA. Depending upon supply voltage and external components, this can provide up to 8 watts of output power.

The ZXLD1352 includes the output switch and a high-side output current sensing circuit, which uses an external resistor to set the nominal average output current.

Output current can be adjusted above, or below the set value, by applying an external control signal to the 'ADJ' pin.

Features

- Simple low parts count
- Internal 30V NDMOS switch
- 350mA output current
- Single pin on/off and brightness control using DC voltage or PWM
- 1000:1 PWM dimming range
- Soft-start
- High efficiency (up to 95%^(*))
- Wide input voltage range: 7V to 30V
- 40V transient capability
- Output shutdown
- Up to 1MHz switching frequency
- Inherent open-circuit LED protection
- Typical 4% output current accuracy

(*) Using standard external components as specified under electrical characteristics. Efficiency is dependent upon the number of LEDs driven and on external component types and values.

Pin connections

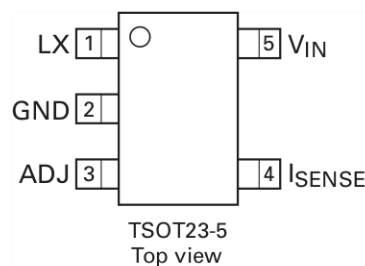

The ADJ pin will accept either a DC voltage or a PWM waveform. DC voltages between 0.3V and 2.5V allow adjustment of output current from 25% to 200% of nominal. 1000:1 adjustment of output current is possible using PWM control.

Applying a voltage of 0.2V or lower to the ADJ pin turns the output off and switches the device into a low current standby state.

The device is assembled in a TSOT23-5 pin package.

Applications

- Low voltage halogen replacement LEDs
- Automotive lighting
- Low voltage industrial lighting
- LED back-up lighting
- Illuminated signs

Typical application circuit

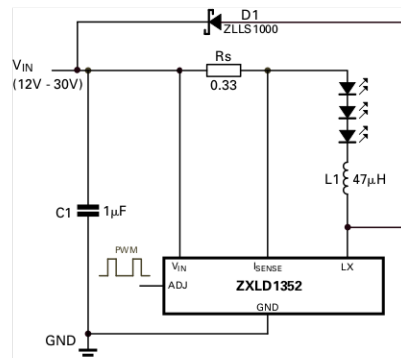

Absolute maximum ratings (voltages to GND unless otherwise stated)

Input voltage (V_{IN})	-0.3V to +30V (40V for 0.5 sec)
I_{SENSE} voltage (V_{SENSE})	+0.3V to -5V (measured with respect to V_{IN})
LX output voltage (V_{LX})	-0.3V to +30V (40V for 0.5 sec)
Adjust pin input voltage (V_{ADJ})	-0.3V to +6V
Switch output current (I_{LX})	500mA
Power dissipation (P_{tot})	450mW
(Refer to package thermal de-rating curve on page 18)	
Operating temperature (T_{OP})	-40 to 105°C
Storage temperature (T_{ST})	-55 to 150°C
Junction temperature ($T_{j\ MAX}$)	150°C

These are stress ratings only. Operation above the absolute maximum rating may cause device failure. Operation at the absolute maximum ratings, for extended periods, may reduce device reliability.

Thermal resistance

Junction to ambient ($R_{\theta JA}$)	200°C/W
---	---------

Electrical characteristics (test conditions: $V_{IN}=12V$, $T_{amb}=25^\circ C$ unless otherwise stated) (*)

Symbol	Parameter	Conditions	Min.	Typ.	Max.	Unit
V_{IN}	Input voltage		7		30	V
V_{SU}	Internal regulator start-up threshold	V_{IN} rising		4.8		V
I_{INQoff}	Quiescent supply current with output off	ADJ pin grounded		20	30	μA
I_{INQon}	Quiescent supply current with output switching	ADJ pin floating $f=250kHz$		250	500	μA
V_{SENSE}	Mean current sense threshold voltage (defines LED current setting accuracy)	Measured on I_{SENSE} pin with respect to V_{IN} $V_{ADJ}=1.25V$	95	100	105	mV
$V_{SENSEHYS}$	Sense threshold hysteresis			± 15		%
I_{SENSE}	I_{SENSE} pin input current	$V_{SENSE}=V_{IN}-0.1$		1.25	10	μA
V_{REF}	Internal reference voltage	Measured on ADJ pin with pin floating	1.21	1.25	1.29	V
$\Delta V_{REF}/\Delta T$	Temperature coefficient of V_{REF}			50		ppm/°C
V_{ADJ}	External control voltage range on ADJ pin for dc brightness control ^(†)		0.3		2.5	V
V_{ADJoff}	DC voltage on ADJ pin to switch device from active (on) state to quiescent (off) state	V_{ADJ} falling	0.15	0.2	0.25	V
V_{ADJon}	DC voltage on ADJ pin to switch device from quiescent (off) state to active (on) state	V_{ADJ} rising	0.2	0.25	0.3	V
R_{ADJ}	Resistance between ADJ pin and V_{REF}		35		65	$k\Omega$
I_{LXmean}	Continuous LX switch current				0.37	A
R_{LX}	LX Switch 'On' resistance			1.5	2	Ω
$I_{LX(leak)}$	LX switch leakage current				1	μA

ZXLD1352

Electrical characteristics (test conditions: $V_{IN}=12V$, $T_{amb}=25^{\circ}C$ unless otherwise stated) (*) (continued)

Symbol	Parameter	Conditions	Min.	Typ.	Max.	Unit
$D_{PWM(LF)}$	Duty cycle range of PWM signal applied to ADJ pin during PWM dimming mode	PWM frequency 100Hz - 1KHz PWM amplitude= V_{REF} Measured on ADJ pin	0.01		1	
	Brightness control range			1000:1		
f_{LX}	Operating frequency (See graphs for more detail)	ADJ pin floating $L=100\mu H$ (0.82 Ω) $I_{OUT}=350mA$ @ $V_{LED}=3.4V$ Driving 1 LED		250		KHz
T_{ONmin}	Minimum switch 'ON' time	LX switch 'ON'	200			ns
T_{OFFmin}	Minimum switch 'OFF' time	LX switch 'OFF'	200			ns
f_{LXmax}	Recommended maximum operating frequency				1	MHz
D_{LX}	Recommended duty cycle range of output switch at f_{LXmax}		0.3		0.7	
T_{PD}	Internal comparator propagation delay			50		ns

NOTES:

(*) Production testing of the device is performed at 25°C. Functional operation of the device and parameters specified over a -40°C to +105°C temperature range, are guaranteed by design, characterization and process control.

(†) 100% brightness corresponds to $V_{ADJ} = V_{ADJ(nom)} = V_{REF}$. Driving the ADJ pin above V_{REF} will increase the V_{SENSE} threshold and output current proportionally.

Pin description

Name	Pin No.	Description
LX	1	Drain of NDMOS switch
GND	2	Ground (0V)
ADJ	3	Multi-function On/Off and brightness control pin: <ul style="list-style-type: none"> Leave floating for normal operation. ($V_{ADJ} = V_{REF} = 1.25V$ giving nominal average output current $I_{OUTnom}=0.1/R_S$) Drive to voltage below 0.2V to turn off output current Drive with DC voltage ($0.3V < V_{ADJ} < 2.5V$) to adjust output current from 25% to 200%^(†) of I_{OUTnom} Drive with PWM signal from open-collector or open-drain transistor, to adjust output current. Adjustment range 1% to 100% of I_{OUTnom} for 100Hz < f < 1KHz Connect a capacitor from this pin to ground to define soft-start time. Soft-start time is approx.0.5ms/nF)
I_{SENSE}	4	Connect resistor R_S from this pin to V_{IN} to define nominal average output current $I_{OUTnom}=0.1/R_S$ (Note: $R_{SMIN}=0.27\Omega$ with ADJ pin open-circuit)
V_{IN}	5	Input voltage (7V to 30V). Decouple to ground with 1 μF or higher X7R ceramic capacitor close to device

Ordering information

Device	Reel size (mm)	Reel width (mm)	Quantity per reel	Device mark
ZXLD1352ET5TA	180	8	3,000	1352

Block diagram

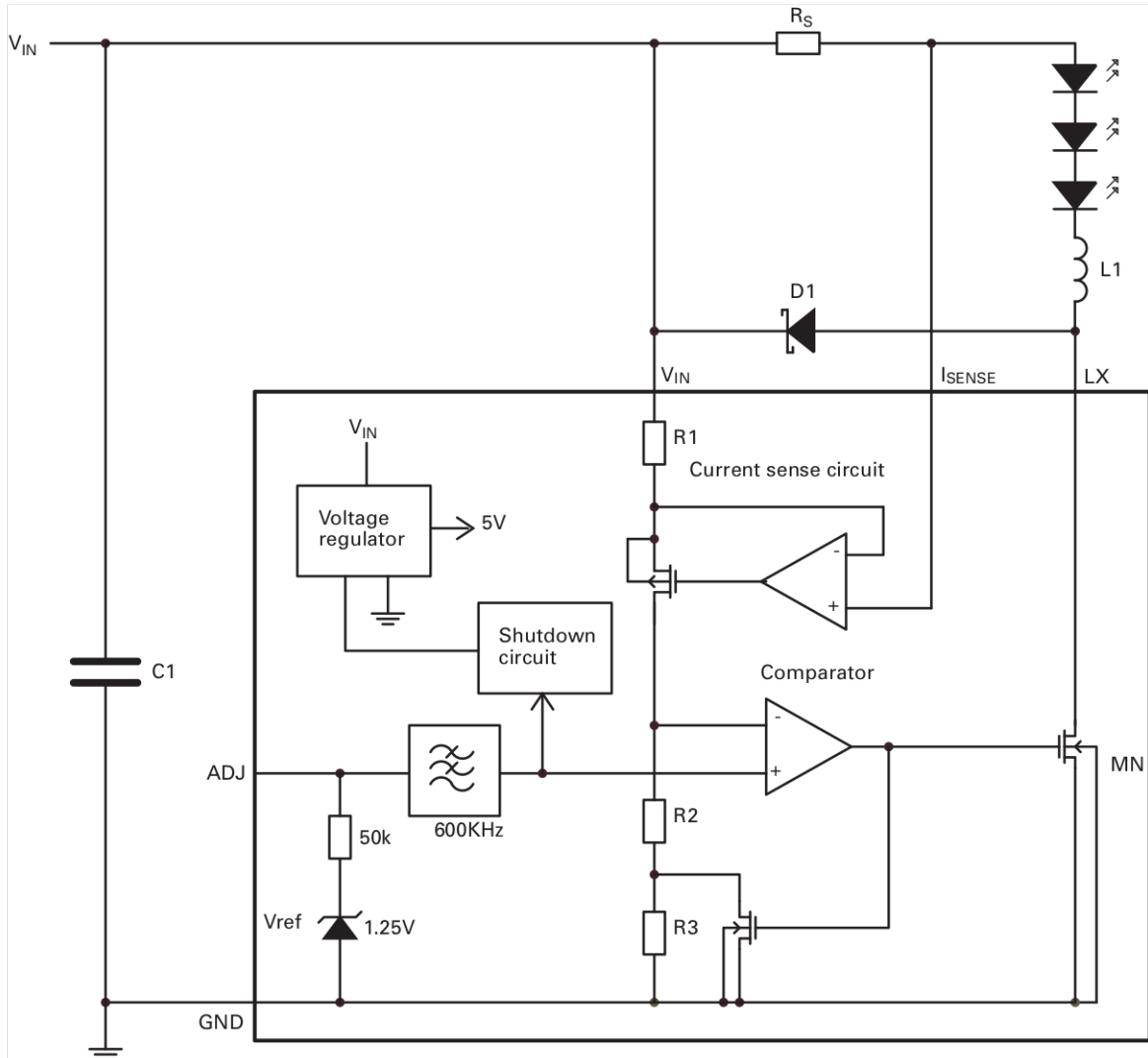

Device description

The device, in conjunction with the coil (L1) and current sense resistor (R_S), forms a self-oscillating continuous-mode buck converter.

Device operation (Refer to block diagram and Figure 1 - Operating waveforms)

Operation can be best understood by assuming that the ADJ pin of the device is unconnected and the voltage on this pin (V_{ADJ}) appears directly at the (+) input of the comparator.

When input voltage V_{IN} is first applied, the initial current in L1 and R_S is zero and there is no output from the current sense circuit. Under this condition, the (-) input to the comparator is at ground and its output is high. This turns MN on and switches the LX pin low, causing current to flow from V_{IN} to ground, via R_S , L1 and the LED(s). The current rises at a rate determined by V_{IN} and L1 to produce a voltage ramp (V_{SENSE}) across R_S . The supply referred voltage V_{SENSE} is forced across internal resistor R1 by the current sense circuit and produces a proportional current in internal resistors R2 and R3. This produces a ground referred rising voltage at the (-) input of the comparator. When this reaches the threshold voltage (V_{ADJ}), the comparator output switches low and MN turns off. The comparator output also drives another NMOS switch, which bypasses internal resistor R3 to provide a controlled amount of hysteresis. The hysteresis is set by R3 to be nominally 15% of V_{ADJ} .

When MN is off, the current in L1 continues to flow via D1 and the LED(s) back to V_{IN} . The current decays at a rate determined by the LED and diode forward voltages to produce a falling voltage at the input of the comparator. When this voltage returns to V_{ADJ} , the comparator output switches high again. This cycle of events repeats, with the comparator input ramping between limits of $V_{ADJ} \pm 15\%$.

Switching thresholds

With $V_{ADJ} = V_{REF}$, the ratios of R1, R2 and R3, define an average V_{SENSE} switching threshold of 100mV (measured on the I_{SENSE} pin with respect to V_{IN}). The average output current I_{OUTnom} is then defined by this voltage and R_S according to:

$$I_{OUTnom} = 100mV/R_S$$

Nominal ripple current is $\pm 15mV/R_S$

Adjusting output current

The device contains a low pass filter for noise suppression between the ADJ pin and the threshold comparator and an internal current limiting resistor (50k nom) between ADJ and the internal reference voltage. This allows the ADJ pin to be overdriven with either DC or PWM signals to adjust the output current. The filter is first order, comprising one section with a cut-off frequency of nominally 600kHz.

Details of the different modes of adjusting output current are given in the applications section.

Output shutdown

The ADJ pin drives the shutdown circuit. When the input voltage to this circuit falls below the threshold (0.2V nom), the internal regulator and the output switch are turned off. The voltage reference remains powered during shutdown to provide the bias current for the shutdown circuit. Quiescent supply current during shutdown is nominally 20 μ A and switch leakage is below 1 μ A.

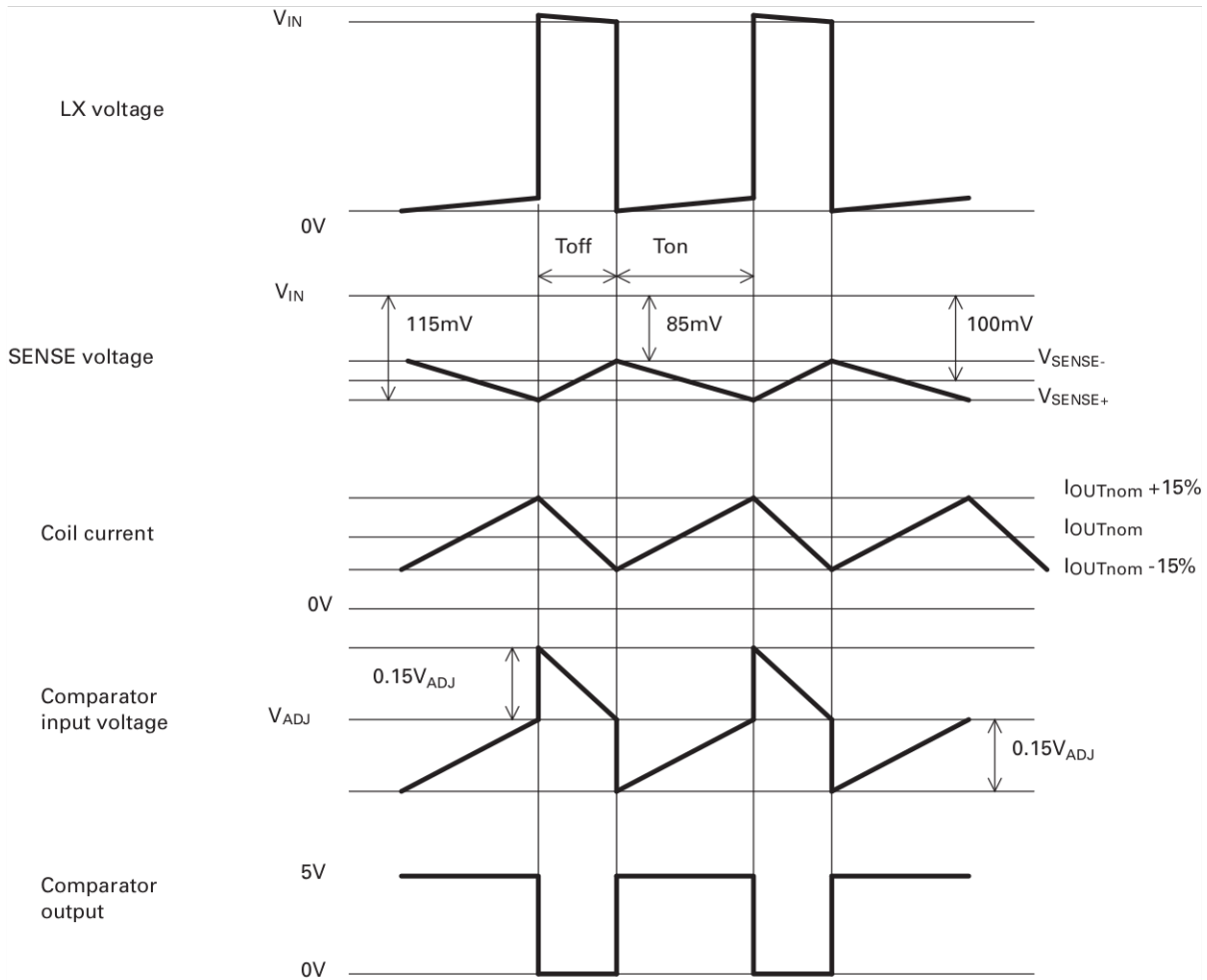
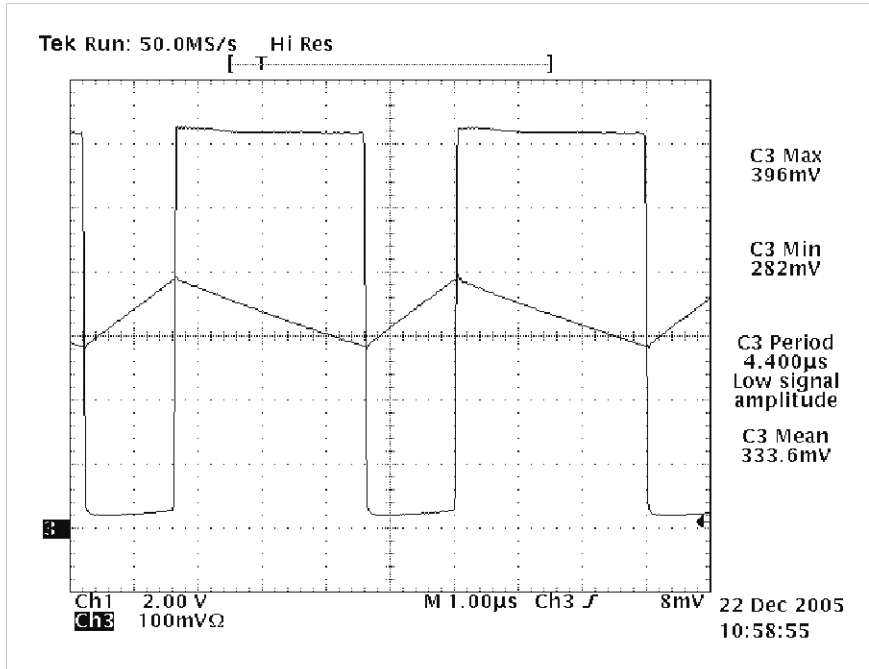
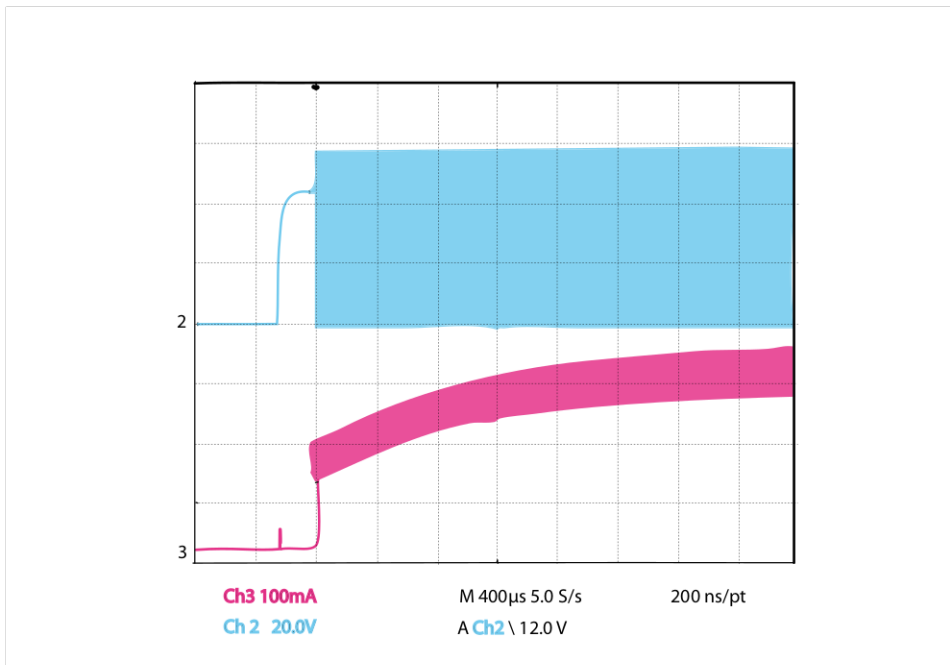

Figure 1 Operating waveforms

Typical operating waveforms [$V_{IN}=12V$, $R_S=0.3\Omega$, $L=100\mu H$]



Normal operation. Output current (Ch3) and LX voltage (Ch1)



Start-up waveforms. Output current (Ch3), LX voltage (Ch2)

Typical operating conditions

For typical application circuit driving 1W Luxeon® white LED(s) at $V_{IN}=12V$ and $T_{amb}=25^{\circ}C$ unless otherwise stated.

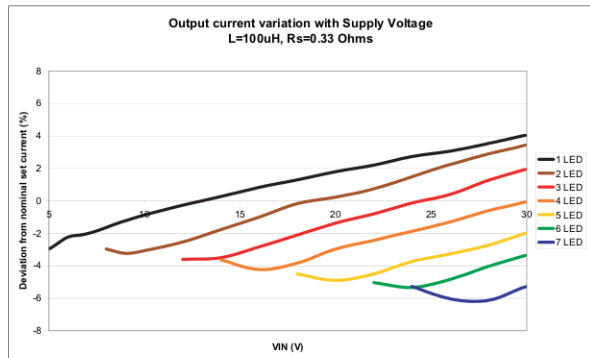
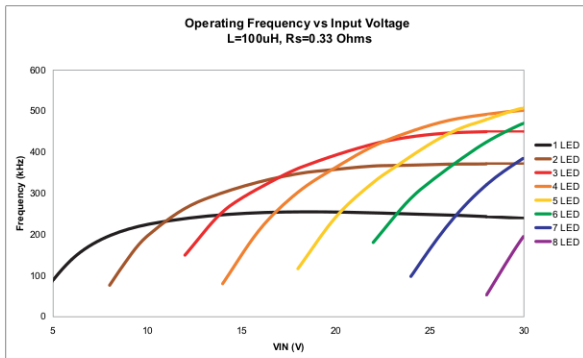
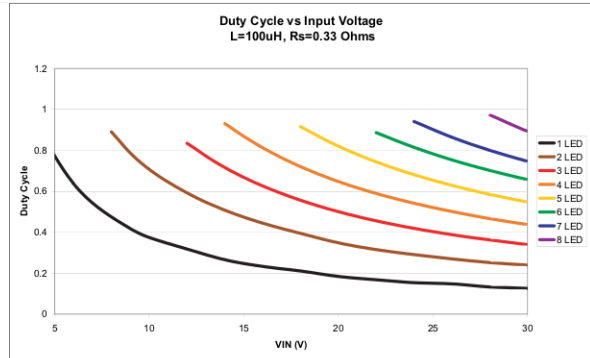
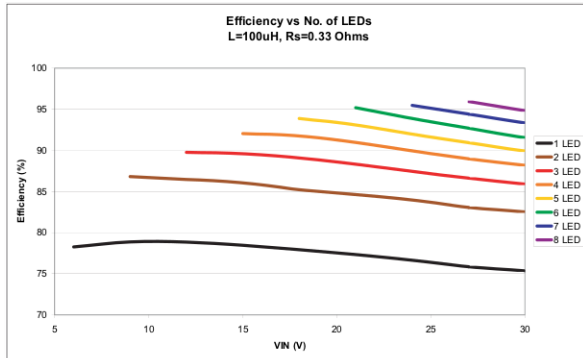

Typical operating conditions (continued)

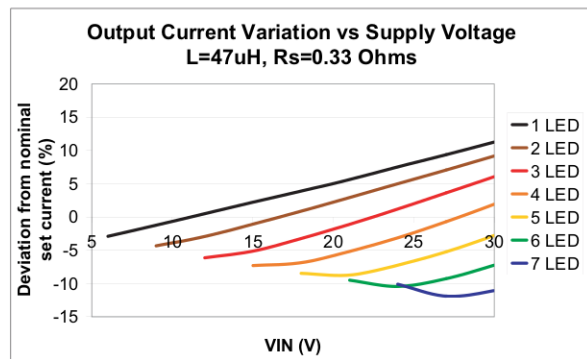
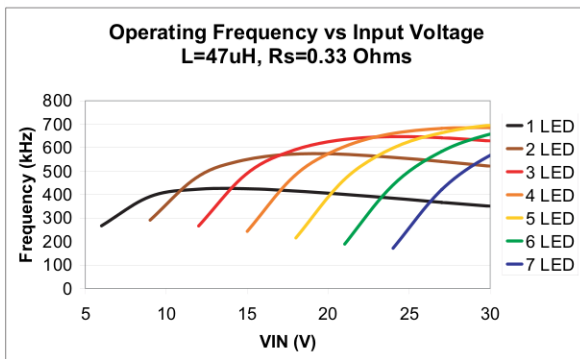
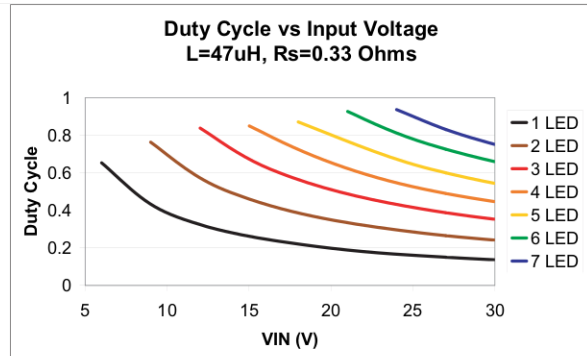
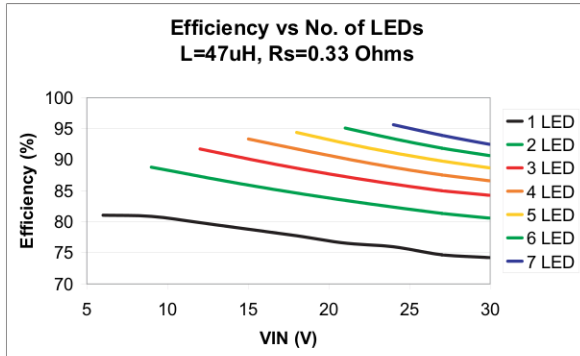

Typical operating conditions (continued)

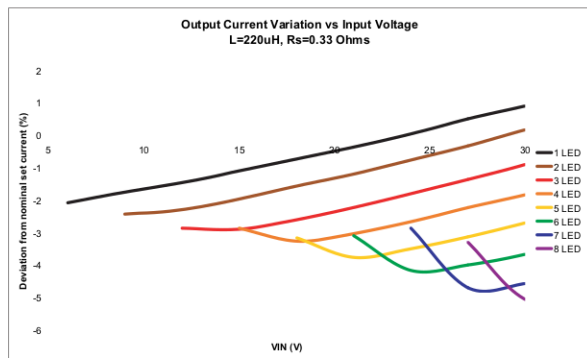
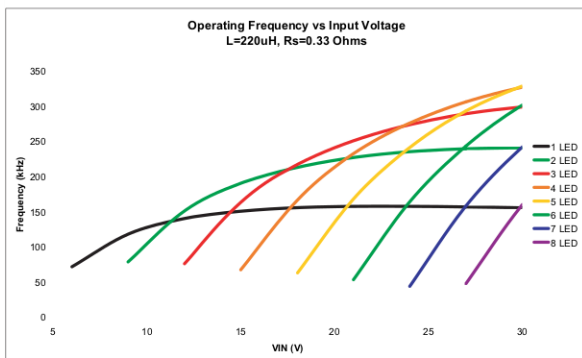
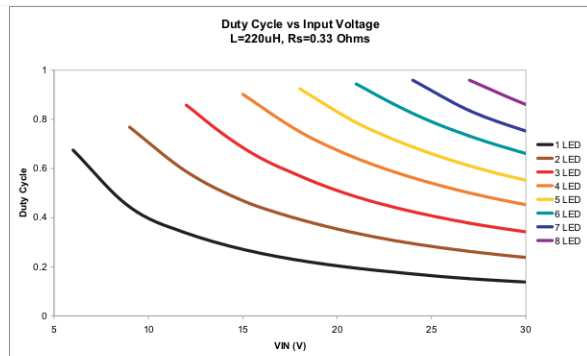
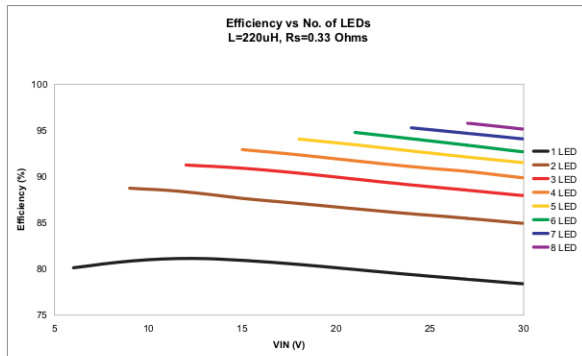

Typical operating conditions (continued)

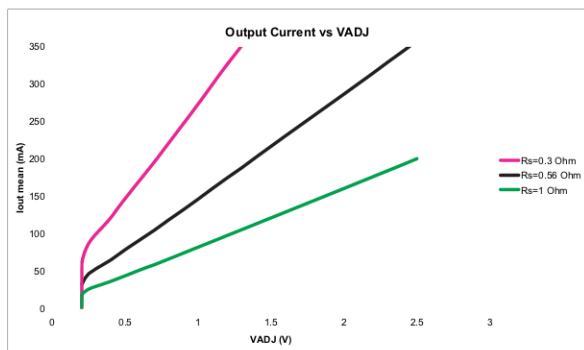
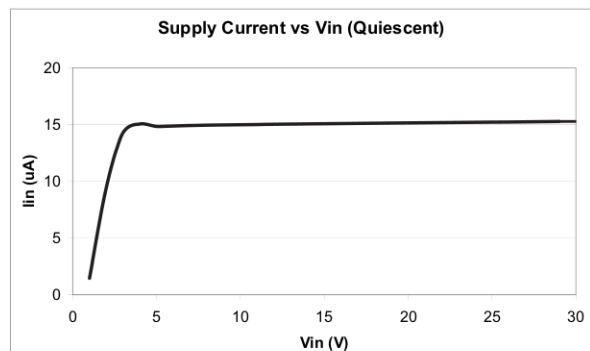
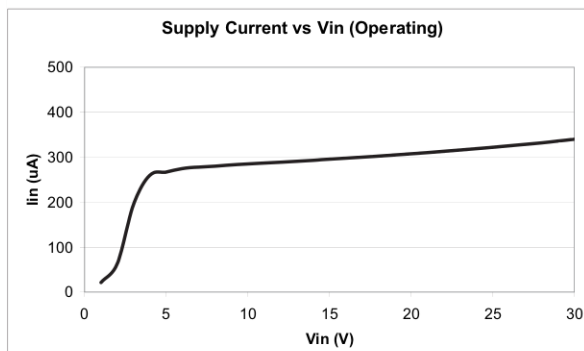
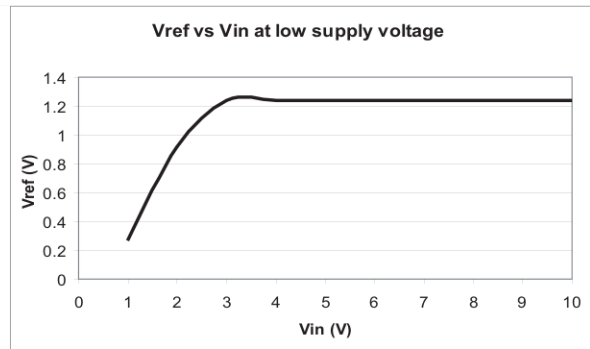
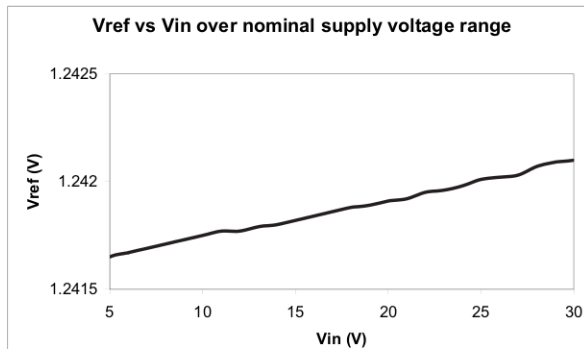

Typical operating conditions (continued)

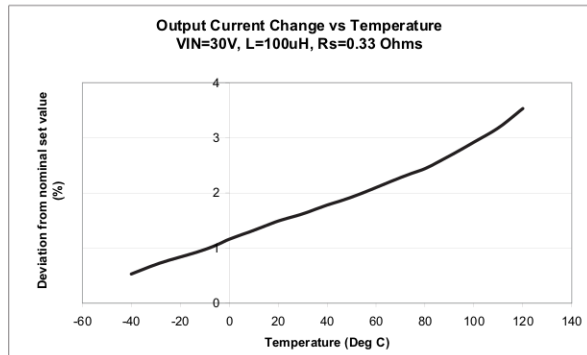
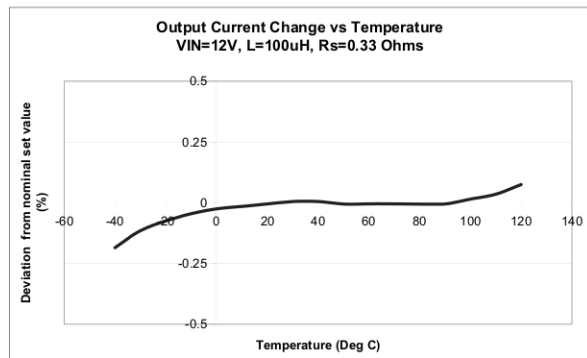
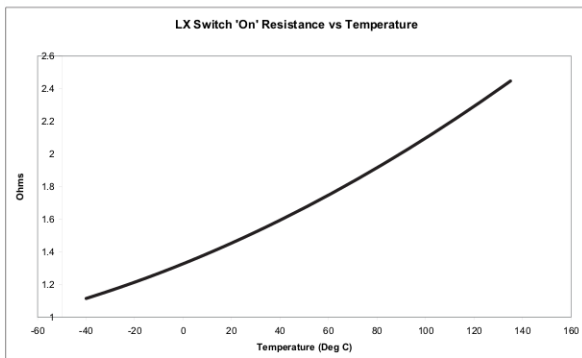
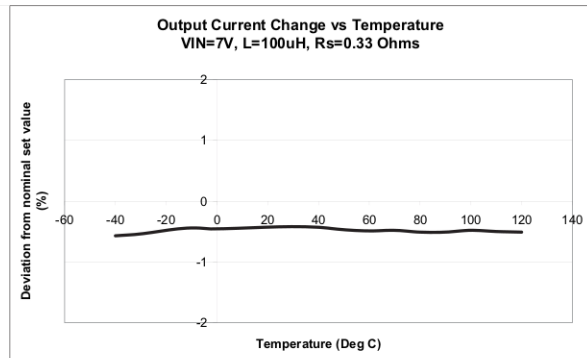
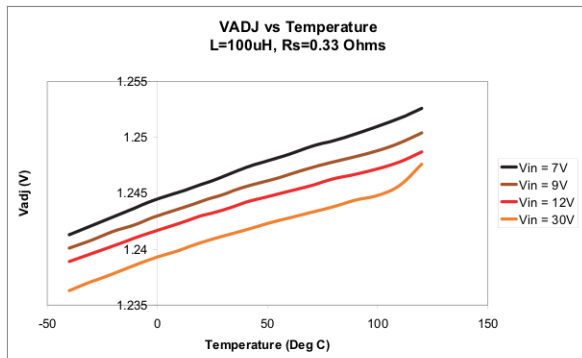

Application notes

Setting nominal average output current with external resistor R_S

The nominal average output current in the LED(s) is determined by the value of the external current sense resistor (R_S) connected between V_{IN} and I_{SENSE} and is given by:

$$I_{OUTnom} = 0.1/R_S \text{ [for } R_S > 0.27\Omega \text{]}$$

The table below gives values of nominal average output current for several preferred values of current setting resistor (R_S) in the typical application circuit shown on page 1:

R_S (Ω)	Nominal average output current (mA)
0.27	370
0.3	333
0.33	300
0.39	256

The above values assume that the ADJ pin is floating and at a nominal voltage of V_{REF} (=1.25V). Note that $R_S=0.27\Omega$ is the minimum allowed value of sense resistor under these conditions to maintain switch current below the specified maximum value.

It is possible to use different values of R_S if the ADJ pin is driven from an external voltage. (See next section).

Output current adjustment by external DC control voltage

The ADJ pin can be driven by an external dc voltage (V_{ADJ}), as shown, to adjust the output current to a value above or below the nominal average value defined by R_S .

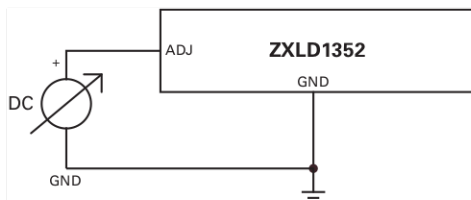

The nominal average output current in this case is given by:

$$I_{OUTdc} = 0.08 * V_{ADJ} / R_S \text{ [for } 0.3 < V_{ADJ} < 2.5V \text{]}$$

Note that 100% brightness setting corresponds to $V_{ADJ} = V_{REF}$. When driving the ADJ pin above 1.25V, R_S must be increased in proportion to prevent I_{OUTdc} exceeding 370mA maximum.

The input impedance of the ADJ pin is $50k\Omega \pm 25\%$.

Output current adjustment by PWM control

Directly driving ADJ input

A Pulse Width Modulated (PWM) signal with duty cycle D_{PWM} can be applied to the ADJ pin, as shown below, to adjust the output current to a value above or below the nominal average value set by resistor R_S :

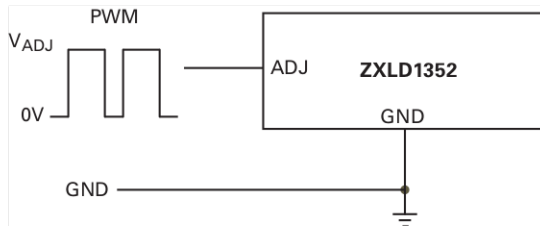

Driving the ADJ input via open collector transistor

The recommended method of driving the ADJ pin and controlling the amplitude of the PWM waveform is to use a small NPN switching transistor as shown below:

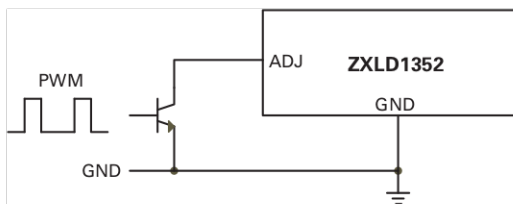

This scheme uses the 50k resistor between the ADJ pin and the internal voltage reference as a pull-up resistor for the external transistor eg MMBT3904.

Driving the ADJ input from a microcontroller

Another possibility is to drive the device from the open drain output of a microcontroller. The diagram below shows one method of doing this:

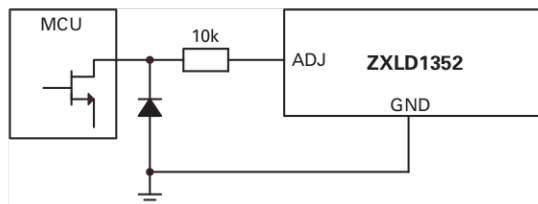

If the NMOS transistor within the microcontroller has high Gate / Drain capacitance, this arrangement can inject a negative spike into ADJ input of the ZXLD1352 and cause erratic operation but the addition of a Schottky clamp diode (eg Diodes Inc. SD103CWS) to ground and inclusion of a series resistor (3.3k) will prevent this. See the section on PWM dimming for more details of the various modes of control using high frequency and low frequency PWM signals

Shutdown mode

Taking the ADJ pin to a voltage below 0.2V will turn off the output and supply current will fall to a low standby level of 20 μ A nominal.

Note that the ADJ pin is not a logic input. Taking the ADJ pin to a voltage above V_{REF} will increase output current above the 100% nominal average value. (See graphs for details).

Soft-start

An external capacitor from the ADJ pin to ground will provide soft-start delay, by increasing the time taken for the voltage on this pin to rise to the turn-on threshold and by slowing down the rate of rise of the control voltage at the input of the comparator. The graph below shows the variation of soft-start time for different values of capacitor.

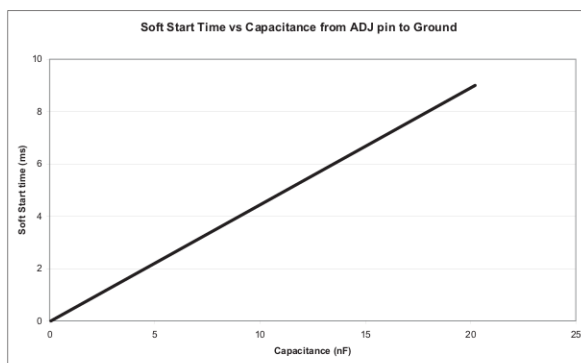

Inherent open-circuit LED protection

If the connection to the LED(s) is open-circuited, the coil is isolated from the LX pin of the chip, so the device will not be damaged, unlike in many boost converters, where the back EMF may damage the internal switch by forcing the drain above its breakdown voltage.

Capacitor selection

A low ESR capacitor should be used for input decoupling, as the ESR of this capacitor appears in series with the supply source impedance and lowers overall efficiency. This capacitor has to supply the relatively high peak current to the coil and smooth the current ripple on the input supply. A minimum value of 1 μ F is acceptable if the input source is close to the device, but higher values will improve performance at lower input voltages, especially when the source impedance is high. The input capacitor should be placed as close as possible to the IC.

For maximum stability over temperature and voltage, capacitors with X7R, X5R, or better dielectric are recommended. Capacitors with Y5V dielectric are not suitable for decoupling in this application and should **NOT** be used.

A table of recommended manufacturers is provided below:

Manufacturer	Website
Murata	www.murata.com
Taiyo Yuden	www.t-yuden.com
Kemet	www.kemet.com
AVX	www.avxcorp.com

Inductor selection

Recommended inductor values for the ZXLD1352 are in the range 47µH to 220µH.

Higher values of inductance are recommended at higher supply voltages in order to minimize errors due to switching delays, which result in increased ripple and lower efficiency. Higher values of inductance also result in a smaller change in output current over the supply voltage range. (See graphs). The inductor should be mounted as close to the device as possible with low resistance connections to the LX and V_{IN} pins.

The chosen coil should have a saturation current higher than the peak output current and a continuous current rating above the required mean output current.

Suitable coils for use with the ZXLD1352 are listed in the table below:

Part No.	L (µH)	DCR (Ω)	I _{SAT} (A)	Manufacturer
DO1608C	47	0.64	0.5	CoilCraft
MSS6132ML	47	0.38	0.56	
	68	0.58	0.47	
	100	0.82	0.39	
CD104-MC	220	0.55	0.53	Sumida
NP04SB470M	47	0.27	0.38	Taiyo Yuden

The inductor value should be chosen to maintain operating duty cycle and switch 'on'/'off' times within the specified limits over the supply voltage and load current range.

The following equations can be used as a guide, with reference to Figure 1 - Operating waveforms.

LX Switch 'On' time

$$T_{ON} = \frac{L\Delta I}{V_{IN} - V_{LED} - I_{avg}(R_S + rL + R_{LX})}$$

Note: T_{ONmin}>200ns

LX Switch 'Off' time

$$T_{OFF} = \frac{L\Delta I}{V_{LED} + VD + I_{avg}(R_S + rL)}$$

Note: T_{OFFmin}>200ns

Where:

L is the coil inductance (H)

rL is the coil resistance (Ω)

I_{avg} is the required LED current (A)

ΔI is the coil peak-peak ripple current (A) {Internally set to 0.3 x I_{avg}}

V_{IN} is the supply voltage (V)

V_{LED} is the total LED forward voltage (V)

R_{LX} is the switch resistance (Ω)

VD is the diode forward voltage at the required load current (V)

Example:

For $V_{IN} = 12V$, $L = 47\mu H$, $rL = 0.64\Omega$, $V_{LED} = 3.4V$, $I_{avg} = 350mA$ and $V_D = 0.36V$

$$T_{ON} = (47e-6 \times 0.105) / (12 - 3.4 - 0.672) = 0.622\mu s$$

$$T_{OFF} = (47e-6 \times 0.105) / (3.4 + 0.36 + 0.322) = 1.21\mu s$$

This gives an operating frequency of 546kHz and a duty cycle of 0.34.

These and other equations are available as a spreadsheet calculator from the Zetex website. Go to www.zetex.com/ZXLD1352

Note that in practice, the duty cycle and operating frequency will deviate from the calculated values due to dynamic switching delays, switch rise/fall times and losses in the external components.

Optimum performance will be achieved by setting the duty cycle close to 0.5 at the nominal supply voltage. This helps to equalize the undershoot and overshoot and improves temperature stability of the output current.

Diode selection

For maximum efficiency and performance, the rectifier (D1) should be a fast low capacitance Schottky diode with low reverse leakage at the maximum operating voltage and temperature. The recommended diode for use with this part is the ZLLS1000. This has approximately ten times lower leakage than standard Schottky diodes, which are unsuitable for use above 85°C. It also provides better efficiency than silicon diodes, due to a combination of lower forward voltage and reduced recovery time.

The table below gives the typical characteristics for the ZLLS1000:

Diode	Forward voltage at 100mA (mV)	Continuous current (mA)	Reverse Leakage At 30V 85°C (μA)	Package	Manufacturer
ZLLS1000	310	1000	300	TSOT23	Zetex

If alternative diodes are used, it is important to select parts with a peak current rating above the peak coil current and a continuous current rating higher than the maximum output load current. It is very important to consider the reverse leakage of the diode when operating above 85°C. Excess leakage will increase the power dissipation in the device.

The higher forward voltage and overshoot due to reverse recovery time in silicon diodes will increase the peak voltage on the LX output. If a silicon diode is used, care should be taken to ensure that the total voltage appearing on the LX pin including supply ripple, does not exceed the specified maximum value.

Reducing output ripple

Peak to peak ripple current in the LED can be reduced, if required, by shunting a capacitor C_{led} across the LED(s) as shown below:

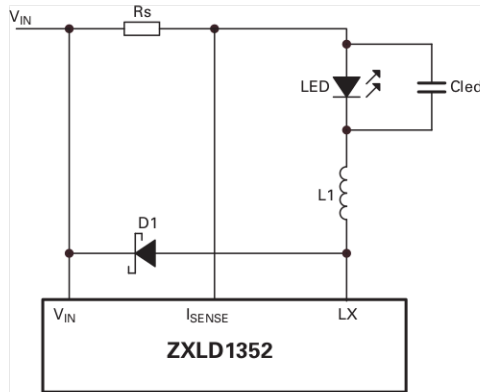

A value of $1\mu\text{F}$ will reduce nominal ripple current by a factor three (approx.). Proportionally lower ripple can be achieved with higher capacitor values. Note that the capacitor will not affect operating frequency or efficiency, but it will increase start-up delay, by reducing the rate of rise of LED voltage.

Operation at low supply voltage

The internal regulator disables the drive to the switch until the supply has risen above the start-up threshold (V_{SU}). Above this threshold, the device will start to operate. However, with the supply voltage below the specified minimum value, the switch duty cycle will be high and the device power dissipation will be at a maximum. Care should be taken to avoid operating the device under such conditions in the application, in order to minimize the risk of exceeding the maximum allowed die temperature. (See next section on thermal considerations).

Note that when driving loads of two or more LEDs, the forward drop will normally be sufficient to prevent the device from switching below approximately 6V. This will minimize the risk of damage to the device.

Thermal considerations

When operating the device at high ambient temperatures, or when driving maximum load current, care must be taken to avoid exceeding the package power dissipation limits. The graph below gives details for power derating. This assumes the device to be mounted on a 25mm^2 PCB with 1oz copper standing in still air.

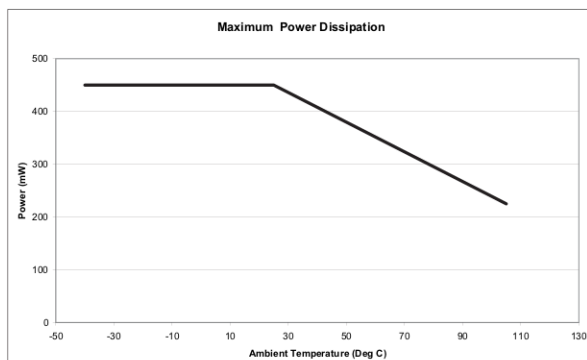

ZXLD1352

Note that the device power dissipation will most often be a maximum at **minimum** supply voltage. It will also increase if the efficiency of the circuit is low. This may result from the use of unsuitable coils, or excessive parasitic output capacitance on the switch output.

Thermal compensation of output current

High luminance LEDs often need to be supplied with a temperature compensated current in order to maintain stable and reliable operation at all drive levels. The LEDs are usually mounted remotely from the device, so for this reason, the temperature coefficients of the internal circuits for the ZXLD1352 have been optimized to minimize the change in output current when no compensation is employed. If output current compensation is required, it is possible to use an external temperature sensing network - normally using Negative Temperature Coefficient (NTC) thermistors and/or diodes, mounted very close to the LED(s). The output of the sensing network can be used to drive the ADJ pin in order to reduce output current with increasing temperature.

Layout considerations

LX pin

The LX pin of the device is a fast switching node, so PCB tracks should be kept as short as possible. To minimize ground 'bounce', the ground pin of the device should be soldered directly to the ground plane.

Coil and decoupling capacitors

It is particularly important to mount the coil and the input decoupling capacitor close to the device to minimize parasitic resistance and inductance, which will degrade efficiency. It is also important to take account of any track resistance in series with current sense resistor R_S .

ADJ pin

The ADJ pin is a high impedance input, so when left floating, PCB tracks to this pin should be as short as possible to reduce noise pickup. A 100nF capacitor from the ADJ pin to ground will reduce frequency modulation of the output under these conditions. An additional series 10k Ω resistor can also be used when driving the ADJ pin from an external circuit (see below). This resistor will provide filtering for low frequency noise and provide protection against high voltage transients.

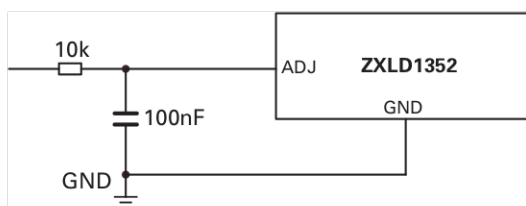

High voltage tracks

Avoid running any high voltage tracks close to the ADJ pin, to reduce the risk of leakage due to board contamination. Any such leakage may raise the ADJ pin voltage and cause excessive output current. A ground ring placed around the ADJ pin will minimize changes in output current under these conditions.

Dimming output current using PWM

When the ADJ pin is driven with a low frequency PWM signal (eg 100Hz), with a high level voltage V_{ADJ} and a low level of zero, the output current will be switched on and off at the PWM frequency, resulting in an average output current I_{OUTavg} proportional to the PWM duty cycle. (See Figure 2)

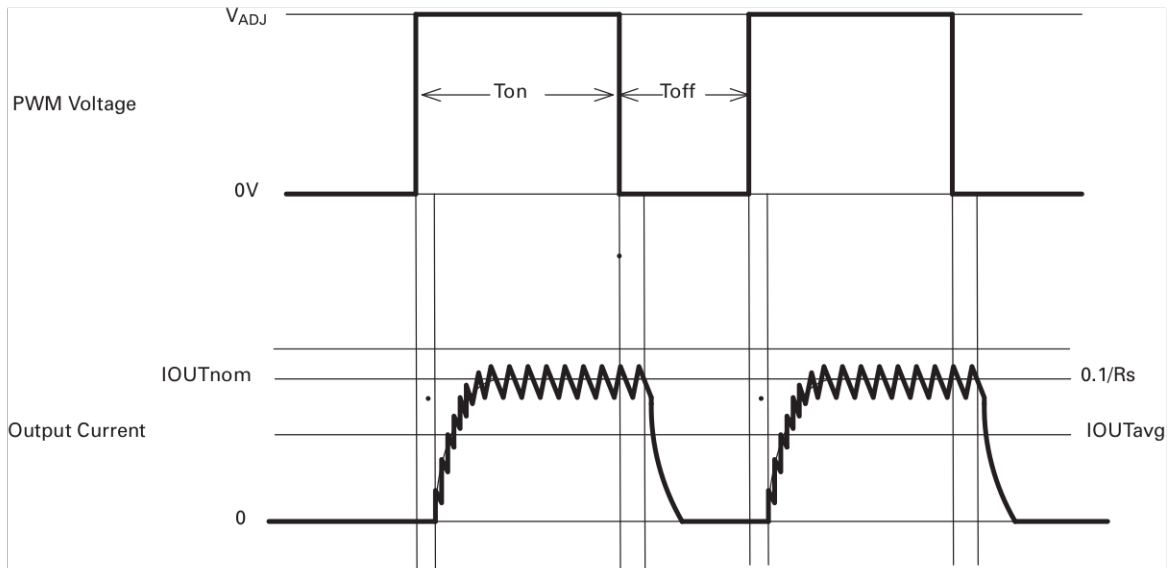

Figure 2 Low frequency PWM operating waveforms

The average value of output current is given by:

$$I_{OUTavg} = 0.1D_{PWM}/R_S \text{ [for } D_{PWM} > 0.01]$$

PWM dimming is preferable to DC dimming if optimum LED 'whiteness' is required. It will also provide the widest possible dimming range (approx. 1000:1) and higher efficiency at the expense of greater output ripple.

ZXLD1352

Package outline - TSOT23-5

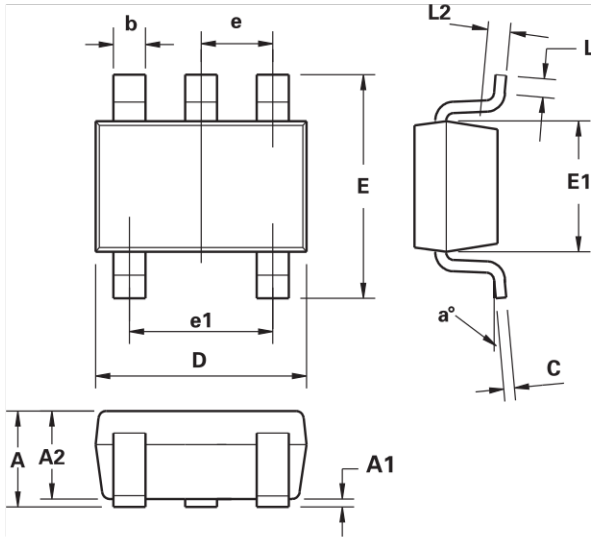

DIM	Millimeters		Inches	
	Min.	Max.	Min.	Max.
A	-	1.00	-	0.0393
A1	0.01	0.10	0.0003	0.0039
A2	0.84	0.90	0.0330	0.0354
b	0.30	0.45	0.0118	0.0177
c	0.12	0.20	0.0047	0.0078
D	2.90 BSC		0.114 BSC	
E	2.80 BSC		0.110 BSC	
E1	1.60 BSC		0.062 BSC	
e	0.95 BSC		0.0374 BSC	
e1	1.90 BSC		0.0748 BSC	
L	0.30	0.50	0.0118	0.0196
L2	0.25 BSC		0.010 BSC	
a°	4°	12°	4°	12°

Note: Controlling dimensions are in millimeters. Approximate dimensions are provided in inches

Definitions

Product change

Diodes Incorporated reserves the right to alter, without notice, specifications, design, price or conditions of supply of any product or service. Customers are solely responsible for obtaining the latest relevant information before placing orders.

Applications disclaimer

The circuits in this design/application note are offered as design ideas. It is the responsibility of the user to ensure that the circuit is fit for the user's application and meets with the user's requirements. No representation or warranty is given and no liability whatsoever is assumed by Diodes Inc. with respect to the accuracy or use of such information, or infringement of patents or other intellectual property rights arising from such use or otherwise. Diodes Inc. does not assume any legal responsibility or will not be held legally liable (whether in contract, tort (including negligence), breach of statutory duty, restriction or otherwise) for any damages, loss of profit, business, contract, opportunity or consequential loss in the use of these circuit applications, under any circumstances.

Life support

Diodes Zetex products are specifically not authorized for use as critical components in life support devices or systems without the express written approval of the Chief Executive Officer of Diodes Incorporated. As used herein:

A. Life support devices or systems are devices or systems which:

1. are intended to implant into the body

or

2. support or sustain life and whose failure to perform when properly used in accordance with instructions for use provided in the labelling can be reasonably expected to result in significant injury to the user.

B. A critical component is any component in a life support device or system whose failure to perform can be reasonably expected to cause the failure of the life support device or to affect its safety or effectiveness.

Reproduction

The product specifications contained in this publication are issued to provide outline information only which (unless agreed by the company in writing) may not be used, applied or reproduced for any purpose or form part of any order or contract or be regarded as a representation relating to the products or services concerned.

Terms and Conditions

All products are sold subjects to Diodes Inc and conditions of sale, and this disclaimer (save in the event of a conflict between the two when the terms of the contract shall prevail) according to region, supplied at the time of order acknowledgement.

For the latest information on technology, delivery terms and conditions and prices, please contact your nearest Diodes Zetex sales office.

Quality of product

Diodes Zetex Semiconductors Limited is an ISO 9001 and TS16949 certified semiconductor manufacturer.

To ensure quality of service and products we strongly advise the purchase of parts directly from Diodes Inc. or one of our regionally authorized distributors. For a complete listing of authorized distributors please visit: www.zetex.com or www.diodes.com

Diodes Incorporated does not warrant or accept any liability whatsoever in respect of any parts purchased through unauthorized sales channels.

ESD (Electrostatic discharge)

Semiconductor devices are susceptible to damage by ESD. Suitable precautions should be taken when handling and transporting devices. The possible damage to devices depends on the circumstances of the handling and transporting, and the nature of the device. The extent of damage can vary from immediate functional or parametric malfunction to degradation of function or performance in use over time. Devices suspected of being affected should be replaced.

Green compliance

Diodes Zetex Semiconductors is committed to environmental excellence in all aspects of its operations which includes meeting or exceeding regulatory requirements with respect to the use of hazardous substances. Numerous successful programs have been implemented to reduce the use of hazardous substances and/or emissions.

All Diodes Zetex components are compliant with the RoHS directive, and through this it is supporting its customers in their compliance with WEEE and ELV directives.

Product status key:

"Preview"	Future device intended for production at some point. Samples may be available
"Active"	Product status recommended for new designs
"Last time buy (LTB)"	Device will be discontinued and last time buy period and delivery is in effect
"Not recommended for new designs"	Device is still in production to support existing designs and production
"Obsolete"	Production has been discontinued

Datasheet status key:

"Draft version"	This term denotes a very early datasheet version and contains highly provisional information, which may change in any manner without notice.
"Provisional version"	This term denotes a pre-release datasheet. It provides a clear indication of anticipated performance. However, changes to the test conditions and specifications may occur, at any time and without notice.
"Issue"	This term denotes an issued datasheet containing finalized specifications. However, changes to specifications may occur, at any time and without notice.

Diodes Zetex sales offices

Europe	Americas	Asia Pacific	Corporate Headquarters
Zetex GmbH Kustermann-Park Balanstraße 59 D-81541 München Germany Telephone: (49) 89 45 49 49 0 Fax: (49) 89 45 49 49 49 europe.sales@zetex.com	Zetex Inc 700 Veterans Memorial Highway Hauppauge, NY 11788 USA Telephone: (1) 631 360 2222 Fax: (1) 631 360 8222 usa.sales@zetex.com	Diodes Zetex (Asia) Ltd 3701-04 Metroplaza Tower 1 Hing Fong Road, Kwai Fong Hong Kong Telephone: (852) 26100 611 Fax: (852) 24250 494 asia.sales@zetex.com	Diodes Incorporated 15660 N. Dallas Parkway Suite 850, Dallas, TX 75248, USA Telephone (1) 972 385 2810 www.diodes.com