

# Uni- and Bipolar Hall IC Switches for Magnetic Field Applications

## TLE4905G; TLE4935G; TLE4945-2G

Sensors



Never stop thinking.

Edition 2007-12-05

published by Infineon Technologies AG,  
Am Campeon 1-12,  
81726 München, Germany

© Infineon Technologies AG 2007.  
All Rights Reserved.

**Attention please!**

The information herein is given to describe certain components and shall not be considered as a guarantee of characteristics. Terms of delivery and rights to technical change reserved.

We hereby disclaim any and all warranties, including but not limited to warranties of non-infringement, regarding circuits, descriptions and charts stated herein.

**Information**

For further information on technology, delivery terms and conditions and prices please contact your nearest Infineon Technologies Office ([www.infineon.com](http://www.infineon.com)).

**Warnings**

Due to technical requirements components may contain dangerous substances. For information on the types in question please contact your nearest Infineon Technologies Office.

Infineon Technologies Components may only be used in life-support devices or systems with the express written approval of Infineon Technologies, if a failure of such components can reasonably be expected to cause the failure of that life-support device or system, or to affect the safety or effectiveness of that device or system. Life support devices or systems are intended to be implanted in the human body, or to support and/or maintain and sustain and/or protect human life. If they fail, it is reasonable to assume that the health of the user or other persons may be endangered.



## Uni- and Bipolar Hall IC Switches for Magnetic Field Applications

TLE4905G; TLE4935G;  
TLE4945-2G

### Features

- Digital output signal
- For unipolar and alternating magnetic fields
- Large temperature range
- Temperature compensated magnetic performance
- Protection against reversed polarity
- Output protection against electrical disturbances

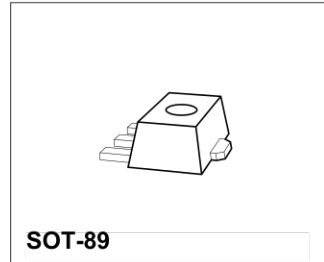

Type	Marking	Ordering Code	Package
TLE4905G	05	Q62705-K402	SOT-89
TLE4935G	35	Q62705-K404	SOT-89
TLE4945-2G	45 2	Q62705-K403	SOT-89

TLE4905/35/45-2 (Unipolar/Bipolar Magnetic Field Switches) have been designed specifically for automotive and industrial applications. Reverse polarity protection is included on-chip as is output protection against negative voltage transients.

Typical applications are position/proximity indicators, brushless DC motor commutation, rotational indexing etc.

### Pin Configuration

(view on branded side of component)

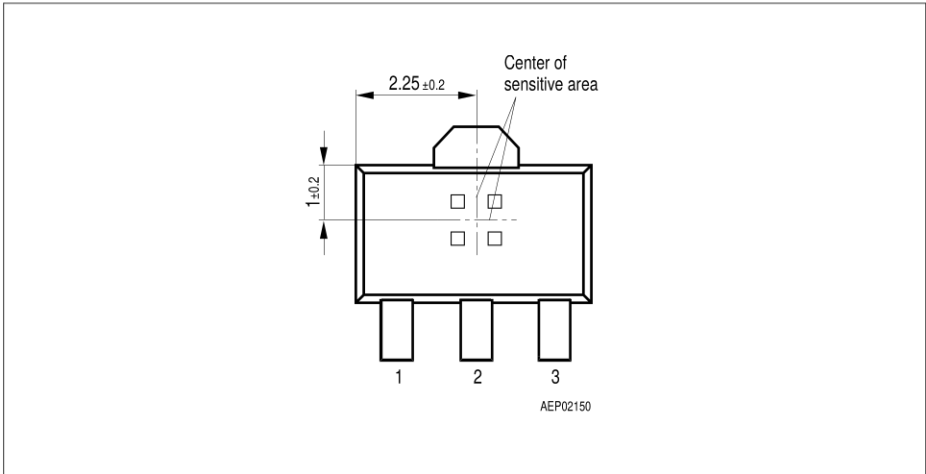

Figure 1

### Pin Definitions and Functions

Pin No.	Symbol	Function
1	$V_S$	Supply voltage
2	GND	Ground
3	Q	Output

### Circuit Description

The circuit includes Hall generator, amplifier and Schmitt-Trigger on one chip. The internal reference provides the supply voltage for the components. A magnetic field perpendicular to the chip surface induces a voltage at the hall probe. This voltage is amplified and switches a Schmitt-trigger with open-collector output. A protection diode against reverse power supply is integrated. The output is protected against electrical disturbances.

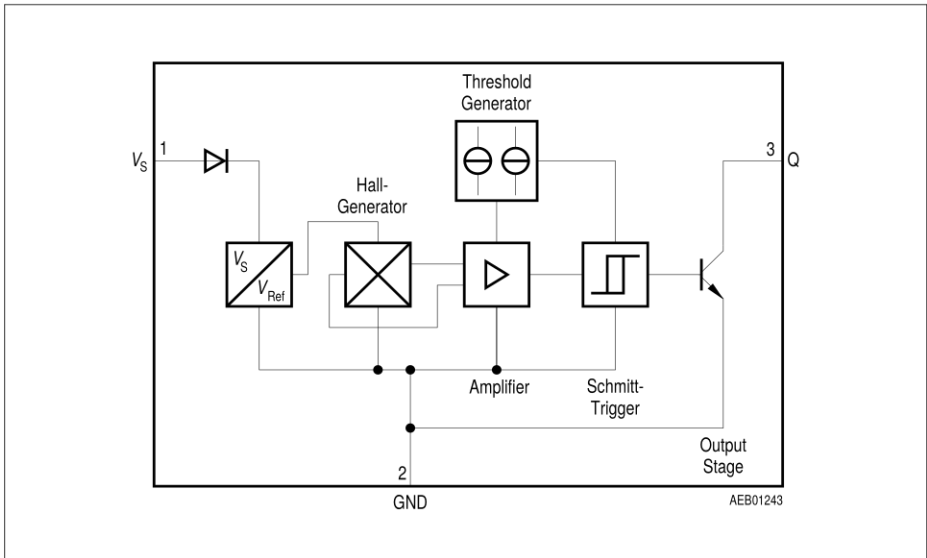
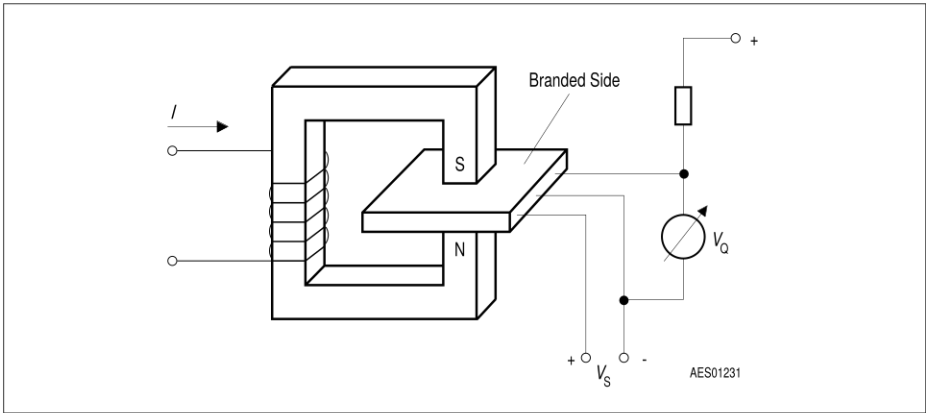

Figure 2 Block Diagram

### Functional Description Unipolar Type TLE4905 (Figure 3 and 4)

When a positive magnetic field is applied in the indicated direction (**Figure 3**) and the turn-on magnetic induction  $B_{OP}$  is exceeded, the output of the Hall-effect IC will conduct (Operate Point). When the magnetic field is reduced to a value smaller than the release point, the output of the IC turns off (Release Point; **Figure 4**).



**Figure 3 Sensor/Magnetic-Field Configuration**

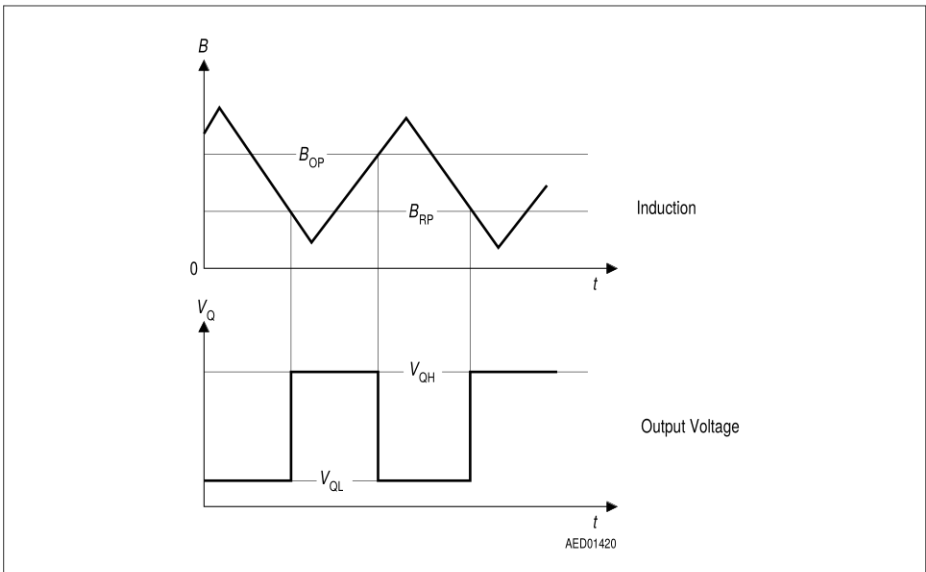

**Figure 4 Switching Characteristics Unipolar Type**

### Functional Description Bipolar Type TLE4935/45-2 (Figure 5 and 6)

When a positive magnetic field is applied in the indicated direction (**Figure 5**) and the turn-on magnetic induction  $B_{OP}$  is exceeded, the output of the Hall-effect IC will conduct (Operate Point). The output state does not change unless a reverse magnetic field exceeding the turn-off magnetic induction  $|B_{RP}|$  is exceeded. In this case the output will turn off (Release Point; **Figure 6**).

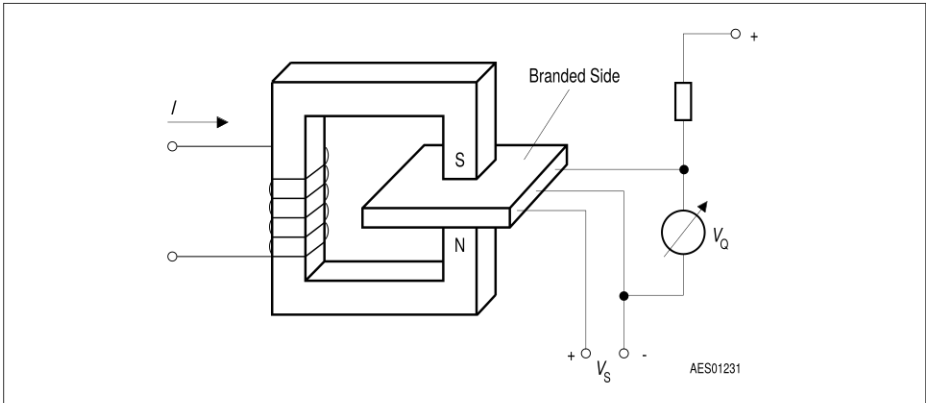

**Figure 5 Sensor/Magnetic-Field Configuration**

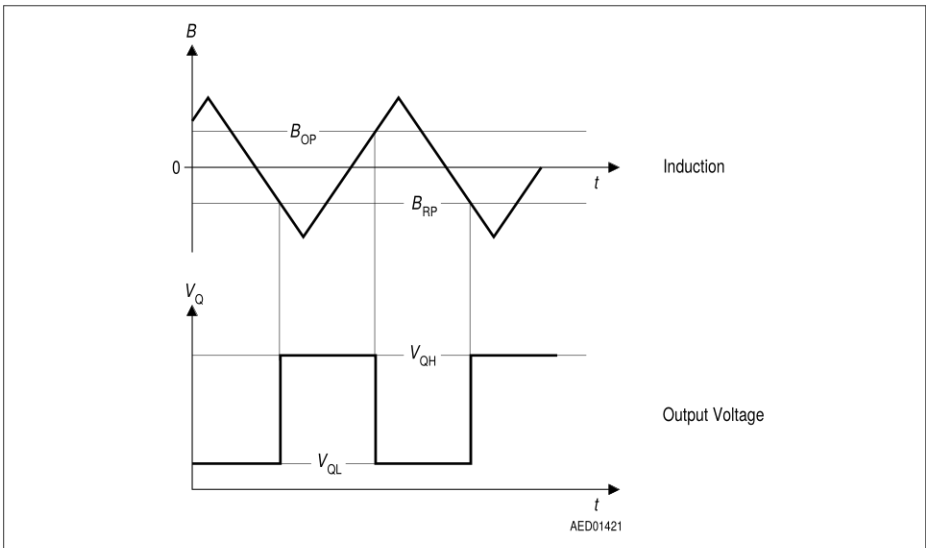

**Figure 6 Switching Characteristics Bipolar Type**

**Absolute Maximum Ratings**
 $T_j = -40$  to  $150$  °C

Parameter	Symbol	Limit Values		Unit	Remarks
		min.	max.		
Supply voltage	$V_S$	- 40	32	V	-
Supply voltage	$V_S$	-	40	V	$t < 400$ ms; $v = 0.1$
Output voltage	$V_Q$	-	32	V	-
Output current	$I_Q$	-	100	mA	-
Output reverse current	$-I_Q$	-	100	mA	-
Junction temperature	$T_j$	- 40	150	°C	-
Storage temperature	$T_{stg}$	- 50	150	°C	-
Thermal resistance	$R_{th JA}$	-	100	K/W	-

*Note: Stresses above those listed here may cause permanent damage to the device. Exposure to absolute maximum rating conditions for extended periods may affect device reliability.*

**Operating Range**

Parameter	Symbol	Limit Values		Unit	Remarks
		min.	max.		
Supply voltage	$V_S$	4.0	24	V	-
Junction temperature	$T_j$	- 40	150	°C	-

*Note: In the operating range the functions given in the circuit description are fulfilled.*



### AC/DC Characteristics

$4.0\text{ V} \leq V_S \leq 24\text{ V}$ ;  $-40\text{ }^\circ\text{C} \leq T_j \leq 150\text{ }^\circ\text{C}$

Parameter	Symbol	Limit Values			Unit	Test Condition	Test Circuit
		min.	typ.	max.			
Supply current	$I$	1.6	–	5.0	mA		1
	$I_{\text{SHigh}}$	–	2.5	–	mA	$B < B_{\text{RP}}$	1
	$I_{\text{SLow}}$	–	3.5	–	mA	$B > B_{\text{OP}}$	1
Output saturation voltage	$V_{\text{QSat}}$	–	0.25	0.5	V	$I_{\text{Q}} = 40\text{ mA}$	1
Output leakage current	$I_{\text{QL}}$	–	–	10	$\mu\text{A}$	$V_{\text{Q}} = 18\text{ V}$	1
Rise/fall time	$t_r / t_f$	–	–	1	$\mu\text{s}$	$R_{\text{L}} = 1.2\text{ k}\Omega$ $C_{\text{L}} \leq 33\text{ pF}$	1

*Note: The listed characteristics are ensured over the operating range of the integrated circuit. Typical characteristics specify mean values expected over the production spread. If not otherwise specified, typical characteristics apply at  $T_j = 25\text{ }^\circ\text{C}$  and the given supply voltage.*

**Magnetic Characteristics**
 $4.0\text{ V} \leq V_S \leq 24\text{ V}$ 

Parameter	Symbol	Limit Values						Unit
		TLE4905 unipolar		TLE4935 bipolar latch		TLE4945-2 bipolar switch		
		min.	max.	min.	max.	min.	max.	

**Junction Temperature  $T_j = -40\text{ °C}$** 

Turn-ON induction	$B_{OP}$	7.5	19	10	20	-3	6	mT
Turn-OFF induction	$B_{RP}$	5.5	17	-20	-10	-6	3	mT
Hysteresis ( $B_{OP}-B_{RP}$ )	$\Delta B_H$	2	6.5	20	40	1	5	mT

**Junction Temperature  $T_j = 25\text{ °C}$** 

Turn-ON induction	$B_{OP}$	7	18	10	20	-3	6	mT
Turn-OFF induction	$B_{RP}$	5	16	-20	-10	-6	3	mT
Hysteresis ( $B_{OP}-B_{RP}$ )	$\Delta B_H$	2	6	20	40	1	5	mT

**Junction Temperature  $T_j = 85\text{ °C}$** 

Turn-ON induction	$B_{OP}$	6.5	17.5	10	20	-3	6	mT
Turn-OFF induction	$B_{RP}$	4.5	15	-20	-10	-6	3	mT
Hysteresis ( $B_{OP}-B_{RP}$ )	$\Delta B_H$	2	5.5	20	40	1	5	mT

**Junction Temperature  $T_j = 150\text{ °C}$** 

Turn-ON induction	$B_{OP}$	6	17	10	20	-3	6	mT
Turn-OFF induction	$B_{RP}$	4	14	-20	-10	-6	3	mT
Hysteresis ( $B_{OP}-B_{RP}$ )	$\Delta B_H$	2	5	20	40	1	5	mT

*Note: The listed characteristics are ensured over the operating range of the integrated circuit. Typical characteristics specify mean values expected over the production spread. If not otherwise specified, typical characteristics apply at  $T_j = 25\text{ °C}$  and the given supply voltage.*

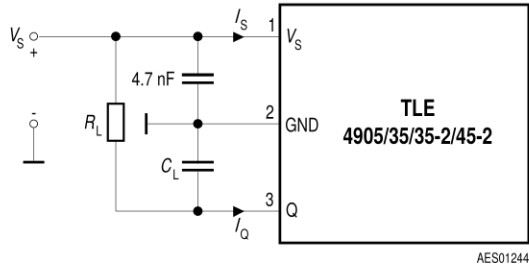

**Unipolar Type TLE4905**

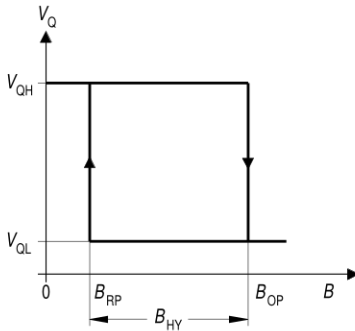

**Bipolar Type TLE4935**

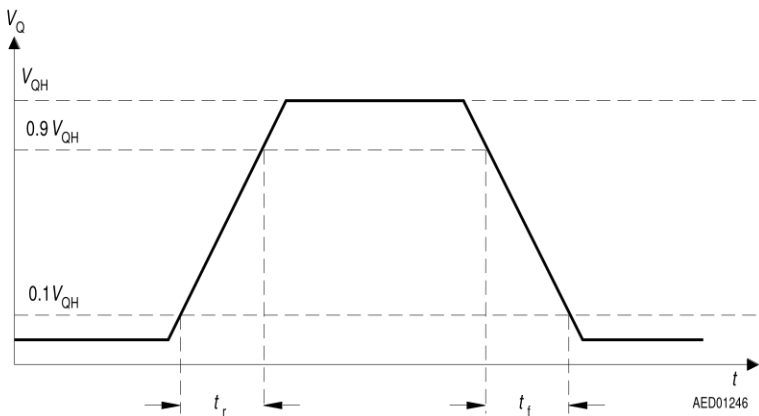
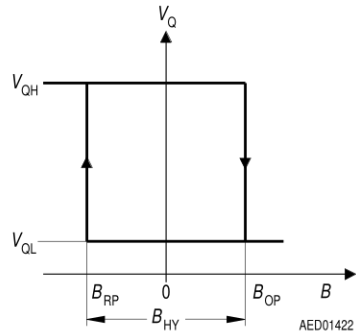

**Figure 7 Test Circuit 1**

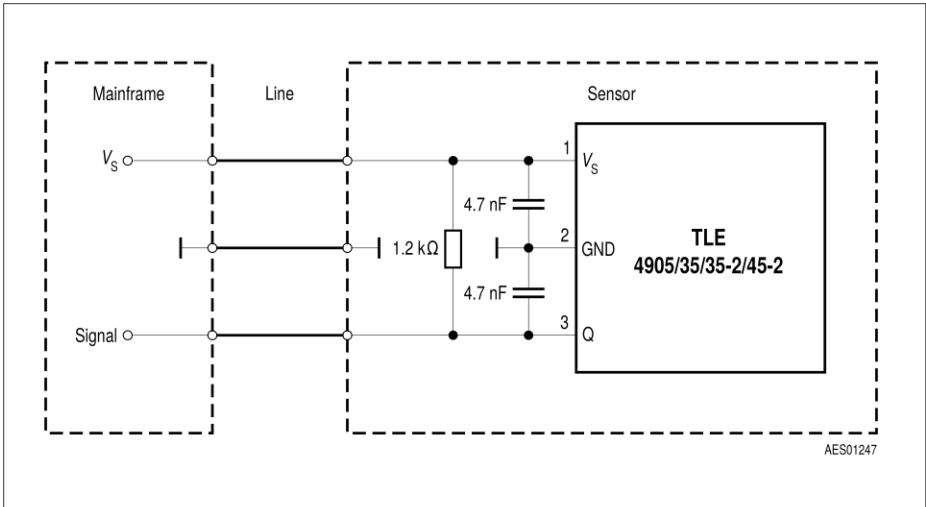
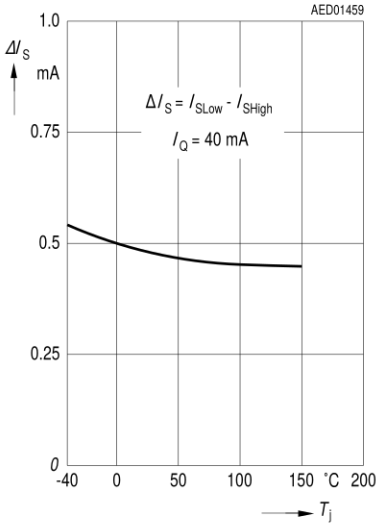

Figure 8 Application Circuit

If not otherwise specified, all curves reflect typical values at  $T_j = 25\text{ }^\circ\text{C}$  and  $V_S = 12\text{ V}$

### Quiescent Current Difference versus Temperature



### Saturation Voltage versus Output Current

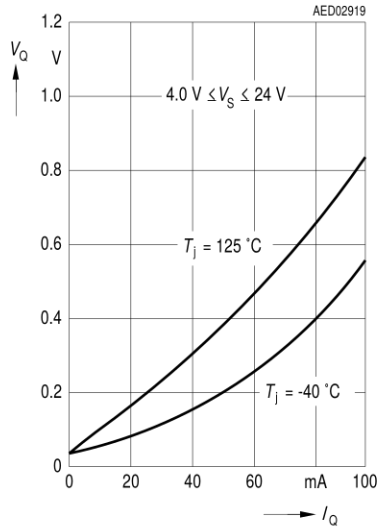

### Quiescent Current versus Junction Temperature

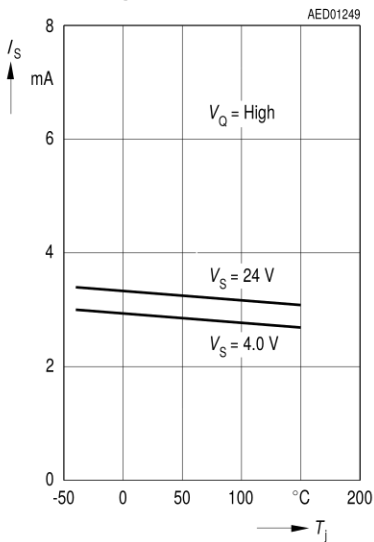

### TLE4905 Operate-and Release-Point versus Junction Temperature

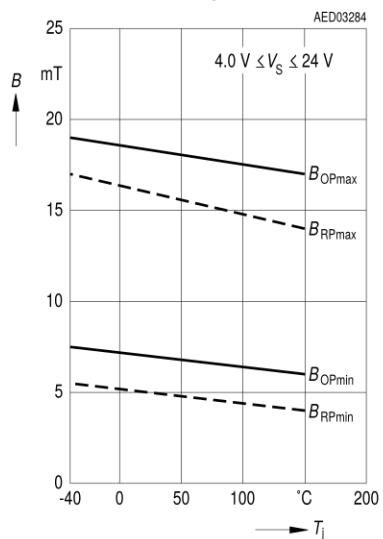

### TLE4935 Operate-and Release-Point versus Junction Temperature

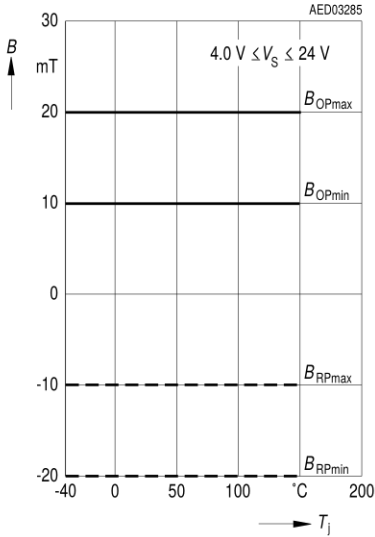

### TTLE4945-2 Operate-and Release-Point versus Junction Temperature

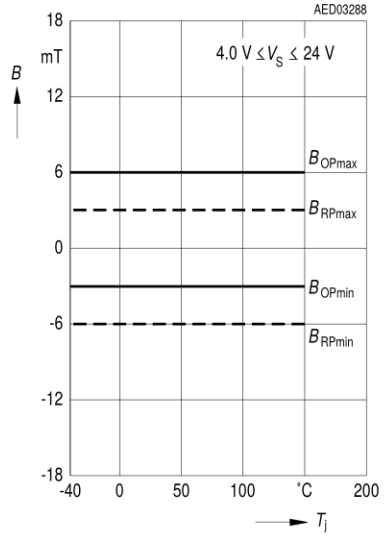

### TLE4905 Hysteresis versus Junction Temperature

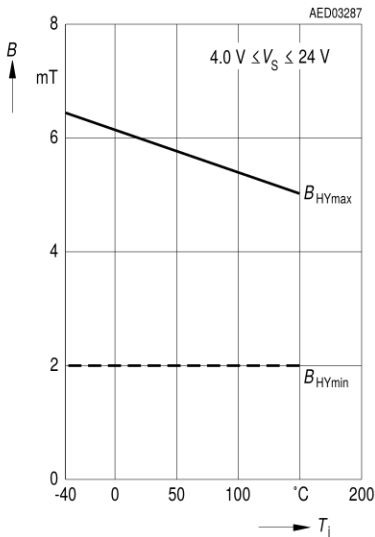

## Package Outlines

### SOT-89 (SMD)

(Plastic Small Outline Transistor Package)

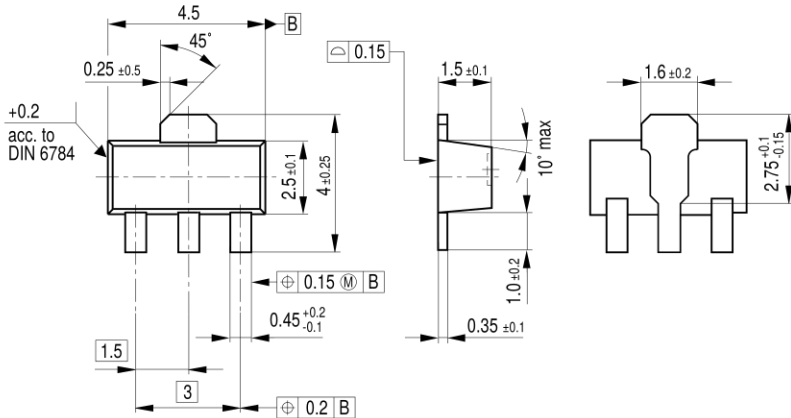

GPS05558

## Package Information

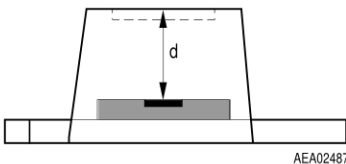

$d$ : Distance chip to upper side of IC  
SOT-89: 1.05 mm

AEA02487

### Sorts of Packing

Package outlines for tubes, trays etc. are contained in our data book "Package Information".

SMD = Surface Mounted Device

Dimensions in mm

---

**Revision History:2007-12-05, V1.3**

---

Previous Version: 2004-03-19, V1.2

---

Page	Subjects (major changes since last revision)
all	TLE4935-2G removed

For questions on technology, delivery and prices please contact the Infineon Technologies offices in Germany or the Infineon Technologies Companies and Representatives worldwide: see our webpage at <http://www.infineon.com>

**We Listen to Your Comments**

Any information within this document that you feel is wrong, unclear or missing at all? Your feedback will help us to continuously improve the quality of this document. Please send your proposal (including a reference to this document) to:

[sensors@infineon.com](mailto:sensors@infineon.com)





[www.infineon.com](http://www.infineon.com)

Published by Infineon Technologies AG